

SAC2500S

SANY All Terrain Crane
250T Lifting Capacity



Max. Lifting Capacity: 250t
Max. Boom Length: 73m
Max. Lifting Height: 110.1m

Basic performance

- Key structural components are optimized with the lifting capacity leading the products of the same tonnage.
- With the max. boom length of 73m and lifting height of 73.5m, it leads the industry.
- Seven-section boom structure and the fully optimized U-shaped high-strength structural steel boom ensure the more uniform stress and lighter weight; mounting angles of jib are 0°, 20° and 40°, which ensure fast and convenient change-over between different operating conditions so as to improve working efficiency.
- Four-wheel drive and six steering modes improve the mobility; the min. turning radius of full-wheel steering is not greater than 10m to improve the trafficability and comfortableness under the complex road conditions.

Excellent quality

- Stable and high-quality hydraulic components such as the main oil pump, main valve, winch motor, slewing motor and balance valve improve the system reliability; superior control performance is ensured through the accurate parameter matching.
- The slewing system is equipped with an integrated slewing buffer valve with free slipping function, which allows for stable slewing and control and superior micro-mobility.
- The crane instrument is integrated with an intelligently controlled integral electrical system, so that operating parameters can be controlled at any time, ensuring superior ride comfort; and meanwhile, the engine fault prompt function is provided to facilitate servicing and troubleshooting.
- Control room consists of the safety glass and corrosion-resistant steel plate, and is configured with the softened interior trim; large interior space, panoramic sunroof, adjustable seats and other user-friendly designs as well as the air conditioning and electric wiper guarantee the more comfortable and easier operation.



Energy saving and environmental protection

- Energy is saved through the hydraulic system load feedback, constant power control, dual variable-speed pump and motor.

Safe and reliable

- The torque limiter calculation system is established based on the lifting model. Through the on-line no-load calibration, the rated lifting accuracy is $\pm 5\%$, providing the all-round protection for the lifting operation. When the overload operation is performed, the system automatically provides the alarm to safeguard the operation.
- Hydraulic system is configured with the hydraulically balanced valve, overflow valve and two-way hydraulic lock etc., to ensure stable and reliable operation.
- Main and auxiliary winches are equipped with three-wrap rope protector. Boom and jib ends are equipped with height limiters respectively to prevent the overfall and overwind of wire rope.
- Length, angle and pressure sensors are configured to display the real-time operating status of crane, and automatically cut off the dangerous action and sound the buzzer.

GCP System

- The remote monitoring and management system, the first of its kind in the country, has the strong acquisition function for operating conditions and parameters, and can implement the remote fault diagnosis and management.
- Customers can monitor the operation of equipment, and query/order the accessories.



Overall Dimensions

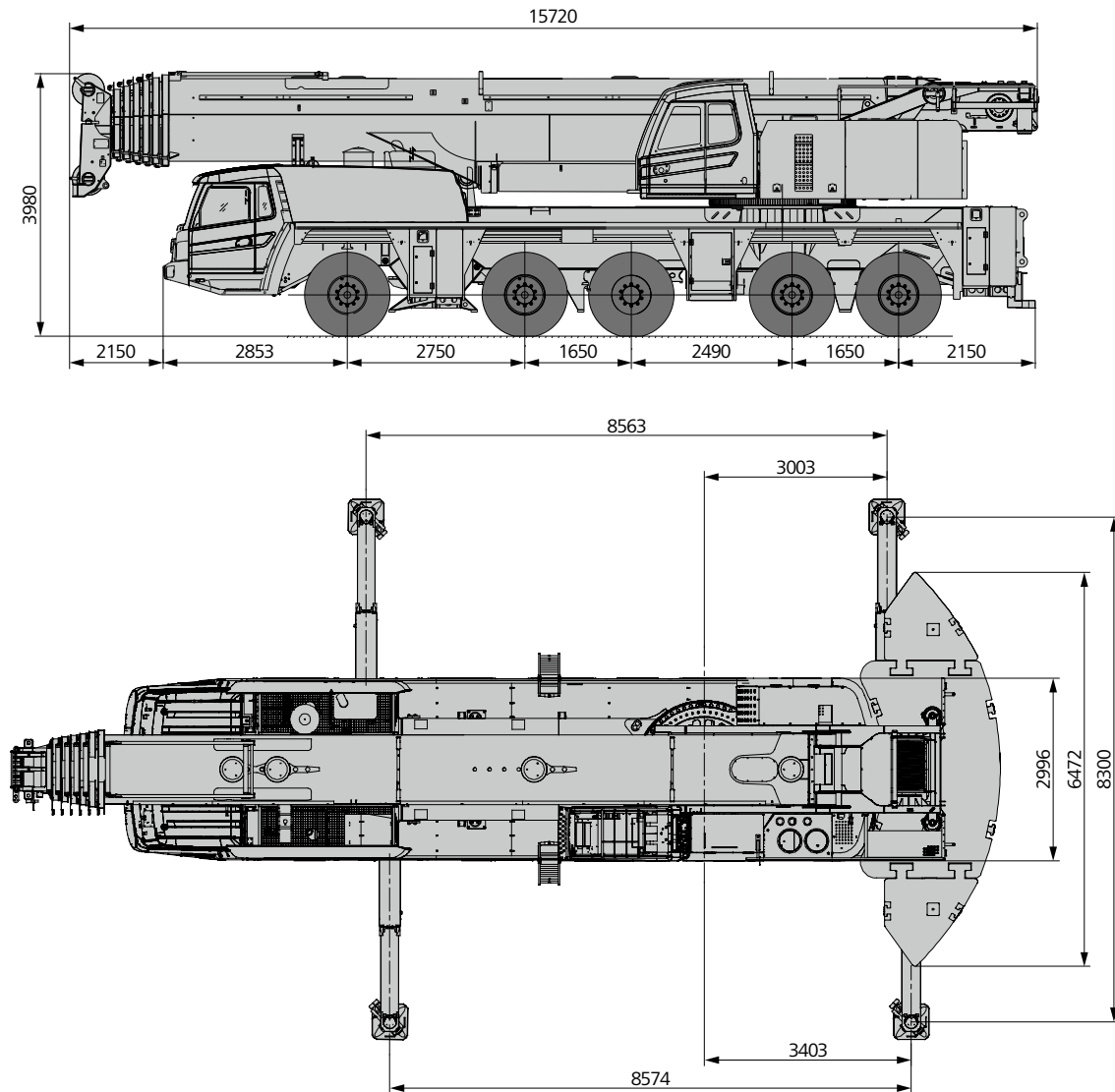

Technical Parameters

Type	Item	Value	
Dimensions	Overall length	15720 mm	
	Overall width	3000 mm	
	Overall height	4000 mm	
	Wheel base	Wheel base – 1, 2	2750 mm
		Wheel base – 2, 3	1650 mm
Wheel base – 3, 4		2490 mm	
Wheel base –4, 5		1650 mm	
Weight	Overall weight	60000 kg	
	Load	Axle load – 1, 2	12000 kg
		Axle load – 3, 4, 5	12000 kg
Power	Max. engine power	OM460LA.E3A	
	Rated power	360 kW / 1800 rpm	
	Rated torque	2200 kW / 1300 rpm	
	Emission standard	Euro III	
Traveling	Max. traveling speed	80 km/h	
	Turning radius	Min. turning radius	10 m
		Min. turning radius of boom head	11 m
	Wheel mode	10 × 8	
	Min. ground clearance	280 mm	
	Approach angle	17°	
	Departure angle	18°	
	Max. gradeability	45%	
	Fuel consumption per 100km	≤ 80 L	
Performance specifications	Operating temperature range	- 25°C~ + 40°C	
	Min. rated radius	3 m	
	Tail slewing radius of turntable	4.85 m	
	Boom sections	7	
	Boom shape	U-shaped	
	Max. lifting torque	Base boom	7409 kN·m
		Fully-extended boom	2860 kN·m
		Max. combination of boom + jib	952 kN·m
	Boom length	Base boom	13.8 m
		Fully-extended boom	73 m
		Max. combination of boom + jib	110.1 m
	Outrigger span(Longitudinal/Transversal)	8.5 m × 8.3 m	
Mounting angle of jib	0°, 20°, 40		
Working speed	Max. single rope lifting speed of main winch (no load)	130 m/min	
	Max. single rope lifting speed of main winch (full load)	45 m/min	
	Max. single rope lifting speed of auxiliary winch (no load)	130 m/min	
	Max. single rope lifting speed of auxiliary winch (full load)	45 m/min	
	Full extension and retraction time of boom	660s / 660s	
	Full lifting/descending time of boom	60s / 90 s	
	Slewing speed	1.5 r/min	
Air conditioning	A/C in superstructure	Cooling and Heating	
	A/C in lower structure	Cooling and Heating	

Technical Parameters



Axle load

Axle	1	2	3	4	5	Overall mass
Axle load / t	12	12	12	12	12	60
Remarks	-					



Hook and multiplying power

Rated load/t	Pulleys	Number of parts of line	Hook weight/kg
125	7	15	1492
80	3	7	685
32	1	3	479
12.5	0	1	270

Crane Introduction

No	Name	Manufacture
1	Engine	BENZ
2	Transmission	ZF
3	Axle 1	KESSLER
4	Axle 2	KESSLER
5	Axle 3	KESSLER
6	Axle 4	KESSLER
7	Axle 5	KESSLER
8	Tire	Techking
9	Piston pump	Rexroth
10	Winch motor	Rexroth\Kawasaki
11	Winch motor	Rexroth\Kawasaki

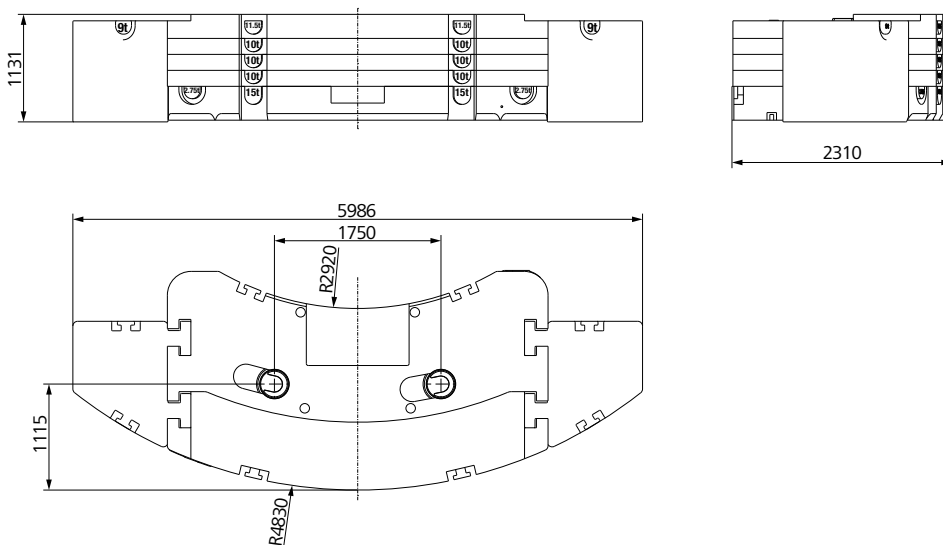

Crane Introduction

Crane frame

- Frame is of the box-shaped structure welded with the high-strength steel plates, with the strong carrying capacity.

Chassis engine

- Model: Mercedes-Benz OM460LA. E3A.
- Type: Inline six-cylinder, water cooling, supercharged and mid-cooling, diesel engine.
- Rated power: 360kw/1800r/min.
- Environmental protection: emissions as per Euro III standard.
- Effective volume of fuel tank: 500L.

Gearbox

- Gearbox: automatic transmission, with 12 forward gears and 2 reverse gears; the large speed ratio range applies to the low-speed climbing and the high-speed driving.

Axle

- Full-axle steering, driven by axles 1, 2, 4 and 5, planetary transmission with interlocking differential lock for axles 1, 2, 4 and 5, hydraulic power steering system of linkage feedback for axles 1 and 2, and electro-hydraulic control steering for axles 3, 4 and 5; the speed control assistance and optional special steering facilitate the control and steering.

Axle suspension

- All axles are equipped with the highly-adjustable oil-gas suspensions with the hydraulic lockout. Suspension height may be passively adjusted for $\pm 150\text{mm}$, with six modes such as the suspension, rigid lock, automatic leveling, overall-crane ascending and descending, single-point ascending and descending and three-axle lifting. It is able to apply to a variety of harsh conditions and road surfaces to ensure the riding comfort and ant-rollover stability.

Tire

- TECHKING #385 as standard; TECHKING / MICHELIN #445, BRIDGESTONE #385 optional. Radial tires.

Brake system

- Parking brake: driven by the accumulator on the axles 2 to 5.
- Service brake: All wheels are equipped with air servo brakes and double-circuit brake system, and all wheels are equipped with drum brakes.
- Auxiliary brake: Engine is equipped with the brake, hydraulic retarder brake and exhaust brake which are able to decelerate in advance, reduce the wear and tear of brake parts and save the use of cost.

Outrigger

- H-shaped telescopic outrigger, 4-point support, vertical/horizontal span of 8.5m \times 8.3m, extension and retraction of full hydraulic level vertical outrigger cylinder; automatic level adjustment.

Control system

- Modern data bus system, 24V DC power supply, one 180AH battery packs; power supply of lower structure may be cut off.
- Chassis is equipped with CAN bus system; multi-functional centralized display system; low power consumption, only 5w; four function keys in the user interface; LCD with the adjustable contrast.

Crane Introduction

Operator's cab

- The ergonomic design independently developed by SANY, sliding door, safety glass, corrosion-resistant steel plate, softened interior trim, large interior space, panoramic sunroof, adjustable seats and other user-friendly designs as well as the air conditioning and electric wiper guarantee the more comfortable and easier operation; the torque limiter display achieves the organic combination of console and display system to monitor all the data of operating conditions.

Boom system

- Boom: seven sections; base boom: 13.8m; fully-extended boom: 73m; lifting height of fully-extended boom: 73.5m; U-shaped and made of high-strength welding structural steel.
- Jib: five sections, respectively 12.2m, 22m, 29m, 36m and 43m; maximum lifting height with jib: 110m; mounting angles: 0°, 20° and 40°.
- Telescopic mechanism: single-cylinder plug extension and retraction, with the full extension and retraction duration only 660S; telescopic mechanism is simple, efficient, safe and reliable.

Turntable structure

- Independently designed by SANY, the structure is more optimized and consists of fine grain high-strength steel.

Hydraulic system of superstructure

- High-quality main oil pump, slewing pump, main valve, winch motor, balance valve and other key hydraulic components are adopted to ensure the stable and reliable hydraulic system; the operating performance is improved through the accurate parameter matching; the electric proportional variable displacement piston pump is used to achieve the real-time adjustment of pump displacement to achieve the high-precision flow control through the change of electric control handle without the energy loss; the dual-pump converging/dividing main valve is independently researched and developed, with higher efficiency of single-action dual-pump convergence and better control of combined dual-pump dividing operation.
- The self-weight luffing-down compensation hydraulic system has the more superior inching performance and stability.
- Boom is provided with the single-cylinder plug extension and retraction system.
- Optional configuration jib is equipped with the luffing cylinder to achieve the stepless luffing from 0° to 40°.
- The closed-type slewing system changes the flow and direction by adjusting the angle of variable pump swash plate, ensuring the superior inching performance and smooth slewing.
- Hydraulic oil tank capacity: 900L.

Slewing system

- 360° rotation, with the maximum slewing speed of 1.5r/min; 1 closed proportional variable pump, 2 axial quantitative piston hydraulic motors; electric proportional closed hydraulic circuit and electric proportional pedal are able to achieve the emergency braking.

Hoisting mechanism

- Main winch is equipped with the electric proportional variable motor with the excellent inching performance and stability, which is able to achieve the stepless speed change and is provided with the original closed-type slewing buffering system to improve the smoothness of slewing start and braking processes and the inching performance. The diameters of wire rope of main and auxiliary winches are both 22mm, and the lengths are 340m and 280m.

Luffing mechanism

- Self-weight luffing-down is more energy efficient. Single cylinder in the front hinged support layout facilitates the luffing operation and improves the stress on the boom; with the electric proportional control balance valve, the luffing angle is from 0° to 82°.

Safety device

- Torque limiter: Based on the analytical mechanics method, the torque limiter calculation system based on the lifting force model is established. Through the on-line no-load calibration, the rated lifting accuracy is up to ±5%, providing the all-round protection for the lifting operation; in case of the overload operation, the system automatically gives alarm to provide the protection for the control operation.
- Hydraulic system is equipped with the hydraulically balanced valve, overflow valve and two-way hydraulic lock etc., to ensure stable and reliable operation.
- Main and auxiliary winches are equipped with three-wrap rope protector to prevent the overfall of wire rope.
- Boom and jib ends are equipped with height limiters respectively to prevent the overwind of wire rope.
- Boom end is equipped with an anemometer to detect whether the high altitude wind speed exceeds the allowable operating range.

Counterweight

- Movable counterweight: 80t.

Boom Operating Range

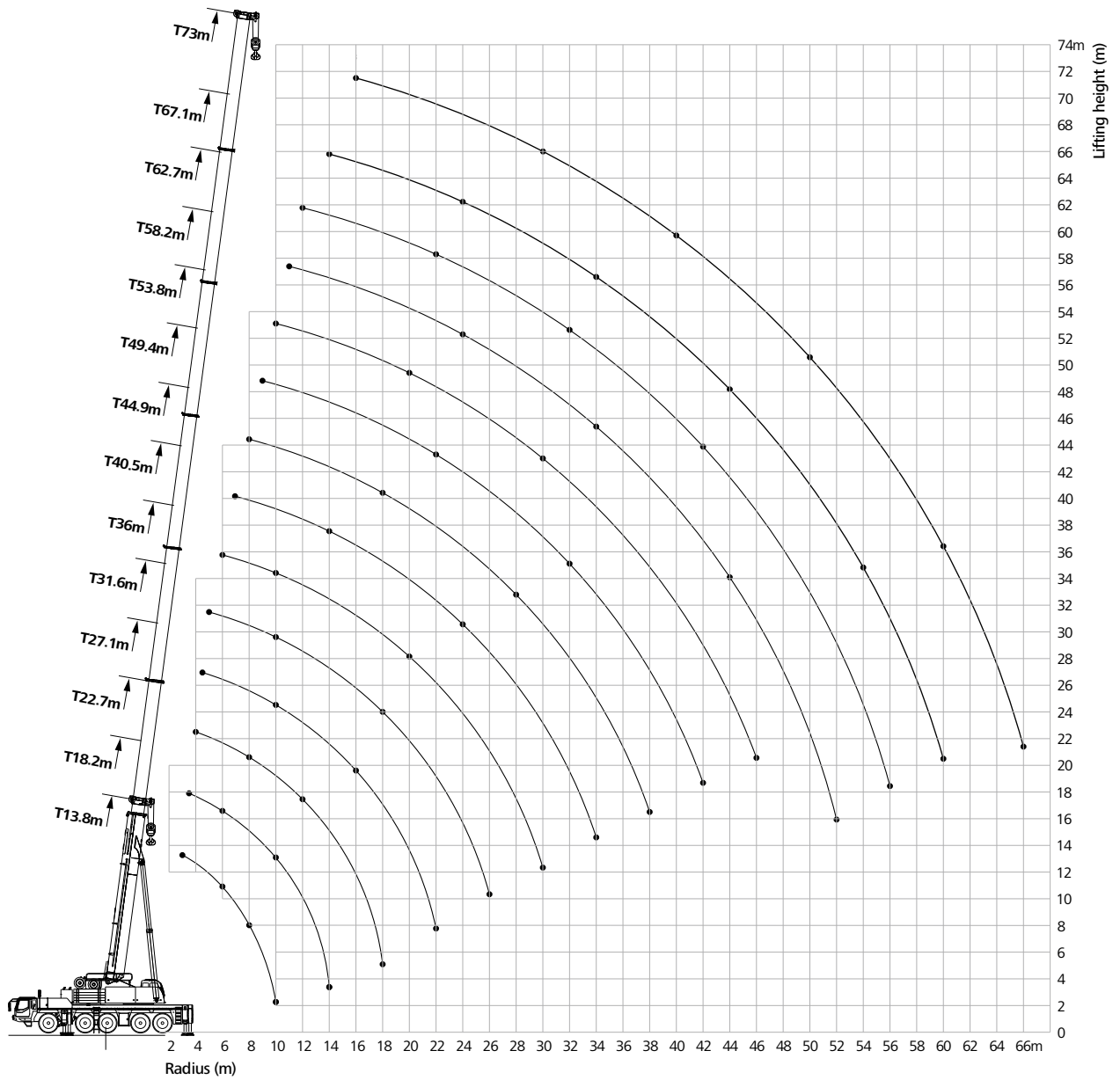

Load Chart - Telescopic Boom

Unit: t

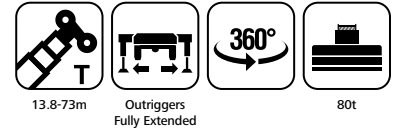

Radius (m)	13.8	18.2	22.6	27.2	31.5	36.1	40.4	44.9	49.4	53.8	58.2	62.7	67.1	73	Radius (m)
3	250.0														3
3.5	160.0	155.0													3.5
4	150.0	145.0	140.0												4
4.5	145.0	136.0	132.0	120.0											4.5
5	135.0	128.0	123.0	115.0	110.0										5
6	120.0	113.0	110.0	103.0	101.0										6
7	106.0	102.0	99.0	92.0	95.0	85.0									7
8	94.5	92.5	90.0	83.0	87.0	80.0	65.0								8
9	83.5	83.5	82.0	77.1	79.3	73.5	62.0	51.5							9
10	72.0	76.0	75.0	71.1	73.0	68.0	59.0	47.9	40.9						10
11		71.5	69.0	65.5	67.5	62.0	56.0	44.6	38.7	35.0					11
12		63.0	61.0	57.4	60.0	59.0	53.0	41.8	36.8	32.2	27.7				12
14		50.5	50.0	45.5	48.0	50.0	49.0	37.5	32.8	30.5	26.6	21.0			14
16			41.5	39.0	40.5	42.0	42.0	33.5	29.3	27.5	23.9	20.8	18.1	13.5	16
18			35.5	33.5	34.5	36.0	36.0	29.7	26.5	24.6	21.6	19.3	17.0	13.4	18
20				29.0	30.0	31.0	31.0	25.3	24.2	21.3	19.8	17.6	15.9	13.0	20
22				24.8	26.0	27.5	27.5	24.0	22.0	19.5	18.0	16.2	14.9	12.1	22
24					23.0	24.5	24.5	21.4	20.2	18.0	16.7	15.0	14.0	11.3	24
26					20.5	22.5	21.5	19.6	18.3	16.6	15.4	14.0	13.1	10.7	26
28						20.3	19.5	18.4	16.9	15.3	14.4	13.1	12.3	10.0	28
30						18.5	17.5	16.5	15.6	14.1	13.5	12.1	11.4	9.4	30
32							16.2	15.0	14.4	13.1	12.7	11.3	10.7	8.8	32
34							14.8	14.0	13.3	12.1	11.9	10.6	10.0	8.4	34
36								13.0	12.2	11.3	11.1	10.0	9.3	7.9	36
38								11.8	11.2	10.4	10.6	9.5	8.6	7.5	38
40									10.2	9.8	9.5	9.1	8.1	7.1	40
42									9.2	9.0	8.5	8.5	7.8	6.8	42
44										8.5	7.7	8.1	7.5	6.5	44
46										8.0	7.2	7.3	7.2	6.2	46
48										7.3	6.6	6.6	6.8	5.9	48
50											6.2	6.2	6.0	5.7	50
52											5.8	5.8	5.7	5.3	52
54												5.3	5.0	4.8	54
56												5.0	4.6	4.3	56
58													4.2	3.9	58
60													3.9	3.4	60
62														3.0	62

Load Chart - Telescopic Boom

Unit: t

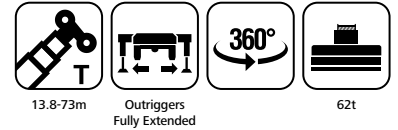

Radius (m)	13.8	18.2	22.6	27.2	31.5	36.1	40.4	44.9	49.4	53.8	58.2	62.7	67.1	73	Radius (m)
3	220.0														3
3.5	160.0	155.0													3.5
4	150.0	145.0	140.0												4
4.5	145.0	135.0	132.0	115.0											4.5
5	135.0	126.0	123.0	110.0	105.0										5
6	120.0	112.0	110.0	103.0	101.0										6
7	106.0	100.5	99.0	92.0	95.0	85.0									7
8	94.5	81.0	90.0	83.0	87.0	80.0	65.0								8
9	83.5	75.0	82.0	77.1	79.3	73.5	62.0	51.5							9
10	72.0	68.0	70.0	64.0	70.0	68.0	59.0	47.9	40.9						10
11		62.0	61.0	59.0	60.0	62.0	56.0	44.6	38.7	33.1					11
12		55.0	53.5	52.0	53.0	59.0	53.0	41.8	36.2	32.2	27.7				12
14		44.5	42.5	42.2	42.2	50.0	45.0	37.5	32.8	28.8	26.6	21.0			14
16			35.0	34.0	34.5	41.5	38.0	33.5	29.3	25.6	23.9	20.8	18.1	13.5	16
18			29.5	28.4	29.3	34.0	32.0	29.0	26.5	23.2	21.6	19.3	17.0	13.4	18
20				23.7	25.0	28.0	27.0	24.6	24.2	21.3	19.8	17.6	15.9	12.5	20
22				20.5	21.7	24.0	23.0	22.7	22.0	19.5	18.0	16.2	14.9	12.0	22
24					19.0	21.0	21.0	20.1	20.2	18.0	16.6	15.0	14.0	11.0	24
26					16.5	18.8	18.0	18.0	17.0	16.4	15.3	14.0	13.1	10.5	26
28						17.0	16.0	15.0	15.0	14.3	14.1	13.1	12.3	10.0	28
30						15.3	14.5	13.5	13.0	12.6	13.0	12.1	11.4	9.4	30
32							13.0	12.5	12.5	11.5	11.6	11.3	10.7	8.8	32
34							11.8	11.5	11.2	10.6	10.3	10.5	10.0	8.4	34
36								10.5	10.4	9.5	9.1	9.6	9.3	7.9	36
38								9.8	9.7	9.0	8.1	8.6	8.6	7.5	38
40									9.1	8.5	7.5	8.0	8.0	7.0	40
42									8.4	8.0	7.0	7.2	7.2	6.0	42
44										7.0	6.5	6.9	6.5	5.5	44
46										6.5	6.1	6.4	5.8	5.0	46
48										5.0	5.6	5.9	5.2	5.0	48
50											5.3	5.4	4.7	4.5	50
52											5.0	5.0	4.2	4.2	52
54												4.6	3.7	3.8	54
56												4.0	3.3	3.4	56
58													2.9	3.0	58
60													2.6	2.6	60
62														2.3	62

Load Chart - Telescopic Boom

Unit: t

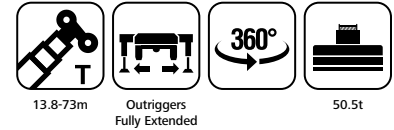

Radius (m)	13.8	18.2	22.6	27.2	31.5	36.1	40.4	44.9	49.4	53.8	58.2	62.7	67.1	73	Radius (m)
3	160.0														3
3.5	155.0	155.0													3.5
4	150.0	145.0	140.0												4
4.5	140.0	135.0	132.0	115.0											4.5
5	130.0	126.0	123.0	110.0	105.0										5
6	115.0	112.0	110.0	103.0	101.0										6
7	102.5	100.5	99.0	92.0	95.0	85.0									7
8	80.0	81.0	90.0	83.0	87.0	80.0	65.0								8
9	70.0	75.0	82.0	77.1	79.3	73.5	62.0	51.5							9
10	63.0	64.0	70.0	64.0	68.0	68.0	59.0	47.9	40.9						10
11		56.5	61.0	58.0	58.0	62.0	56.0	44.6	38.7	33.1					11
12		49.5	51.0	51.0	51.0	57.0	53.0	41.8	36.2	32.2	27.7				12
14		39.5	41.0	40.0	40.2	44.0	45.0	37.5	32.8	28.8	26.6	21.0			14
16			33.5	32.0	33.0	36.3	37.0	33.5	29.3	25.6	23.9	20.8	18.1	13.5	16
18			27.5	26.4	28.3	32.0	31.0	28.0	26.5	23.2	21.6	19.3	17.0	13.4	18
20				21.7	23.6	27.2	26.0	24.6	24.2	21.3	19.8	17.6	15.9	12.5	20
22				19.0	19.9	23.5	22.0	21.2	21.0	19.5	18.0	16.2	14.9	12.0	22
24					17.0	19.5	19.0	18.5	18.2	18.0	16.6	15.0	14.0	11.0	24
26					15.0	17.0	16.5	16.0	16.0	15.5	15.3	14.0	13.1	10.5	26
28						15.0	15.0	14.5	14.0	13.6	14.1	13.1	12.3	10.0	28
30							13.5	13.0	13.5	12.2	12.5	12.5	12.1	11.4	30
32								11.5	12.0	11.4	11.5	11.0	11.3	10.7	32
34								9.6	10.8	10.0	10.0	9.5	10.2	10.0	34
36									9.6	9.0	9.0	8.5	9.6	9.3	36
38									8.4	8.1	8.0	8.0	8.6	8.6	38
40										7.1	7.0	7.5	8.0	7.3	40
42											6.2	6.0	7.0	7.2	42
44												5.2	6.5	6.3	44
46													4.5	6.1	46
48														4.0	48
50															50
52															52
54															54
56															56
58															58
60															60
62															62

Load Chart - Telescopic Boom

Unit: t

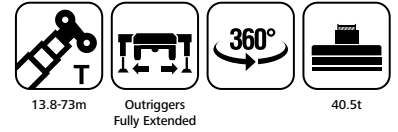

Radius (m)	13.8	18.2	22.6	27.2	31.5	36.1	40.4	44.9	49.4	53.8	58.2	62.7	67.1	73	Radius (m)
3	150.0														3
3.5	150.0	150.0													3.5
4	150.0	145.0	140.0												4
4.5	140.0	135.0	132.0	115.0											4.5
5	125.0	125.0	123.0	110.0	101.0										5
6	105.0	105.0	100.0	102.5	101.0										6
7	90.0	90.0	88.5	88.5	87.0	85.0									7
8	76.5	77.0	75.0	80.0	77.0	78.0	65.0								8
9	68.0	70.0	69.0	68.5	68.3	71.0	62.0	51.5							9
10	60.0	59.5	60.0	60.0	60.6	65.0	59.0	47.9	40.9						10
11		51.0	50.0	55.0	51.1	56.2	56.0	44.6	38.7	33.1					11
12		46.2	45.2	47.0	47.0	48.2	48.2	41.8	36.2	32.2	27.7				12
14		36.0	34.9	35.9	36.9	40.8	37.8	37.0	32.8	28.8	26.6	21.0			14
16			28.2	28.4	29.3	33.0	32.1	29.5	29.3	25.6	23.9	20.8	18.1	13.5	16
18			25.5	22.9	24.8	27.4	26.6	25.9	25.8	23.2	21.6	19.3	17.0	13.4	18
20				19.0	20.6	23.2	22.4	21.7	21.5	21.3	19.8	17.6	15.9	12.5	20
22				16.0	17.2	19.9	19.0	18.3	18.2	18.0	18.0	16.2	14.9	12.0	22
24					14.5	17.2	16.4	16.5	16.0	16.2	15.9	15.0	14.0	11.0	24
26					12.4	15.0	14.2	14.8	14.3	14.1	13.6	14.0	13.1	10.5	26
28						13.1	12.3	13.0	12.5	12.3	12.0	12.4	12.3	10.0	28
30						11.6	10.8	11.5	11.0	10.8	10.2	11.0	11.3	9.4	30
32							9.5	10.1	10.2	9.0	9.5	10.3	9.5	8.8	32
34							8.3	9.0	9.4	7.8	9.0	9.3	8.4	8.0	34
36								8.0	7.9	6.8	8.1	7.9	7.4	7.5	36
38								6.8	7.0	5.9	7.2	7.0	6.5	6.5	38
40									6.2	5.2	6.4	6.2	5.5	5.8	40
42									5.5	4.5	5.7	5.5	5.0	5.1	42
44										3.8	5.0	4.8	4.4	4.4	44
46										3.2	4.5	4.3	3.8	3.9	46
48											3.9	3.7	3.3	3.3	48
50											3.5	3.3	2.8	2.9	50
52											3.0	2.8	2.4	2.4	52
54												2.4	1.9	1.9	54
56												2.0	1.5	1.4	56
58													1.2	1.0	58

Load Chart - Telescopic Boom

Unit: t

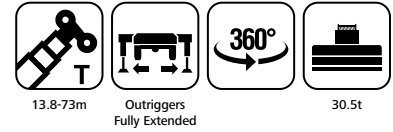

Radius (m)	13.8	18.2	22.6	27.2	31.5	36.1	40.4	44.9	49.4	53.8	58.2	62.7	67.1	73	Radius (m)
3	150.0														3
3.5	150.0	145.0													3.5
4	150.0	145.0	140.0												4
4.5	130.0	135.0	132.0	115.0											4.5
5	120.0	120.0	123.0	110.0	101.0										5
6	100.0	100.0	100.0	102.5	101.0										6
7	85.0	85.5	88.5	88.5	87.0	85.0									7
8	73.5	75.3	72.0	68.0	77.0	78.0	62.0								8
9	64.0	65.0	62.0	57.0	65.3	65.0	60.0	51.5							9
10	54.2	55.4	52.0	47.2	53.3	52.4	55.0	47.9	40.9						10
11		47.3	45.0	40.2	46.2	46.0	48.4	44.6	38.7	33.1					11
12		40.0	39.4	35.3	40.3	40.4	43.4	38.9	36.2	30.9	27.0				12
14		31.5	30.7	27.6	31.6	32.5	33.5	31.8	32.6	28.1	26.6	21.0			14
16			25.0	21.9	24.8	26.6	26.7	25.9	25.8	25.3	23.9	20.8	18.1		16
18			21.0	17.5	19.9	22.0	21.8	21.8	20.9	21.0	21.2	18.3	17.0	13.4	18
20				14.4	16.3	18.9	18.1	18.8	18.2	18.0	17.6	15.6	15.9	12.5	20
22				13.3	13.4	16.0	15.2	15.9	15.4	15.2	14.8	13.6	13.9	12.0	22
24					11.5	13.7	12.9	13.6	14.0	12.9	13.2	12.0	11.0	11.0	24
26					10.5	11.8	11.1	12.6	12.1	11.0	12.2	10.4	9.5	10.5	26
28						10.3	9.6	11.1	10.6	9.5	10.7	9.1	8.6	9.5	28
30						8.9	8.4	9.8	9.2	8.2	9.3	8.0	7.6	8.5	30
32							7.6	8.6	8.1	7.0	8.2	7.0	6.5	7.5	32
34							7.2	7.7	7.1	6.0	7.2	6.1	5.5	6.5	34
36								6.8	6.2	4.9	6.3	5.4	4.8	5.7	36
38								6.0	5.5	4.1	5.6	4.7	4.2	4.8	38
40									4.8	3.5	4.9	4.1	3.5	4.0	40
42									4.2	2.9	4.3	3.5	3.0	3.4	42
44										2.3	3.7	3.0	2.5	2.8	44
46										1.7	3.0	2.6	2.0	2.3	46
48											2.6	2.2	1.5	1.9	48
50											2.1	1.8		1.4	50
52											1.7	1.4		1.0	52

Load Chart - Telescopic Boom

Unit: t

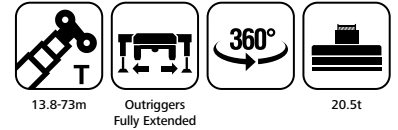

Radius (m)	13.8	18.2	22.6	27.2	31.5	36.1	40.4	44.9	49.4	53.8	58.2	62.7	67.1	73	Radius (m)
3	150.0														3
3.5	150.0	145.0													3.5
4	140.0	140.0	140.0												4
4.5	130.0	130.0	125.0	220.0											4.5
5	120.0	110.0	110.0	220.0	100.0										5
6	100.0	95.0	95.0	186.0	100.0										6
7	85.0	80.0	80.0	160.0	77.5	76.0									7
8	66.0	68.0	66.5	136.0	62.5	60.0	61.0								8
9	55.5	55.0	56.0	111.0	50.5	51.1	50.4	47.5							9
10	45.0	46.1	46.0	89.8	42.0	41.9	42.3	41.2	40.9						10
11		39.4	38.3	76.4	35.3	36.6	35.5	35.5	34.7	33.1					11
12		35.3	34.8	64.3	30.2	32.4	31.0	30.1	30.3	29.9	26.8				12
14		26.6	27.9	47.4	24.7	24.7	24.8	25.1	24.0	24.0	23.6	20.8			14
16			22.1	36.2	19.0	20.9	20.1	20.0	20.0	19.5	19.0	19.8	17.8		16
18			17.9	29.9	16.5	16.7	16.5	17.1	17.0	16.0	17.4	16.4	16.0	13.4	18
20				25.0	14.5	14.6	14.0	15.0	14.0	13.3	14.5	14.4	14.1	12.5	20
22				22.0	13.0	12.2	12.0	13.3	12.5	11.0	12.5	12.2	11.9	12.0	22
24					11.1	11.0	10.2	11.1	10.6	9.4	11.0	10.3	10.0	10.2	24
26					9.5	9.2	9.0	10.2	9.0	8.0	9.0	9.0	8.9	9.0	26
28						7.5	7.8	8.2	7.7	7.0	8.2	8.0	7.5	7.5	28
30						6.5	6.8	7.3	6.8	5.8	7.1	6.8	6.1	6.3	30
32							6.0	6.3	6.0	4.7	6.2	5.7	5.2	5.4	32
34							5.2	5.4	5.0	3.8	5.1	5.0	4.3	4.4	34
36								4.7	4.2	3.1	4.3	4.1	3.6	3.6	36
38								3.8	3.6	2.4	3.6	3.4	3.0	3.0	38
40									2.9	1.8	3.0	2.8	2.3	2.4	40
42									2.2	1.2	2.5	2.2	1.8	1.8	42
44											2.0	1.8	1.2	1.2	44
46											1.5	1.2			46
48											1.0				48

Load Chart - Telescopic Boom

Unit: t

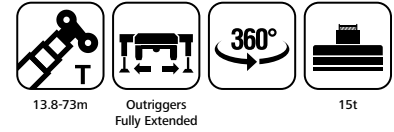

Radius (m)	13.8	18.2	22.6	27.2	31.5	36.1	40.4	44.9	49.4	53.8	58.2	62.7	67.1	73	Radius (m)
3	135.0														3
3.5	135.0	135.0													3.5
4	135.0	135.0	135.0												4
4.5	130.0	130.0	125.0	100.0											4.5
5	120.0	110.0	110.0	100.0	90.0										5
6	90.0	78.0	80.0	75.0	75.0										6
7	68.2	56.0	56.4	53.5	55.3	60.4									7
8	47.0	44.0	47.7	40.2	41.5	45.6	46.3								8
9	39.7	38.0	38.4	33.1	34.7	37.7	36.8	35.6							9
10	33.7	31.3	32.8	27.0	28.8	31.5	30.9	30.0	30.6						10
11		27.8	27.2	24.9	26.0	26.9	25.8	26.5	25.8	23.8					11
12		24.0	24.3	22.8	24.0	23.0	22.0	23.1	23.0	20.9	22.6				12
14		19.5	18.5	18.8	18.5	18.2	17.4	18.3	17.5	15.5	18.0	17.5			14
16			15.3	15.6	15.5	14.6	13.7	14.7	13.5	12.5	13.5	13.5	13.5		16
18			12.9	13.3	13.3	11.8	11.4	11.3	11.0	9.6	10.0	10.4	11.0	11.5	18
20				11.0	11.6	9.8	9.4	9.5	9.1	7.8	7.5	8.0	9.4	9.4	20
22				9.1	9.6	7.8	7.8	8.0	7.2	6.2	6.2	6.5	6.5	7.5	22
24					8.0	6.5	6.5	6.5	6.0	5.0	5.3	5.5	5.2	6.0	24
26					6.7	5.5	5.5	5.5	5.1	4.0	4.5	4.5	4.2	4.8	26
28						4.7	4.5	4.8	4.3	3.2	3.4	3.7	3.5	3.7	28
30							4.0	3.5	4.1	3.5	2.5	2.6	3.0	2.8	30
32								3.0	3.3	2.7	1.8	2.0	2.6	2.1	32
34								2.5	2.7	2.1			2.0	1.5	34
36									2.1	1.5					36
38										1.6					38

Load Chart - Telescopic Boom

Unit: t

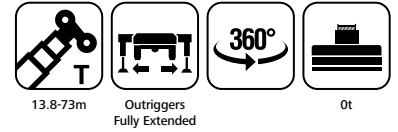

Radius (m)	13.8	18.2	22.6	27.2	31.5	36.1	40.4	44.9	49.4	53.8	58.2	62.7	67.1	73	Radius (m)
3	130.0														3
3.5	130.0	130.0													3.5
4	125.0	120.0	120.0												4
4.5	110.0	107.0	106.0	100.0											4.5
5	100.0	96.0	95.0	100.0	80.0										5
6	78.5	74.0	63.0	60.0	60.0										6
7	55.6	52.7	48.4	42.5	42.6	50.4									7
8	40.5	40.4	37.9	32.3	34.0	38.7	38.6								8
9	31.5	32.9	30.8	28.7	31.0	30.6	31.4	30.9							9
10	25.0	25.1	25.9	26.4	26.0	25.2	25.6	26.0	24.6						10
11		18.6	22.0	22.9	21.2	22.0	20.9	22.3	21.4	20.0					11
12		17.3	19.0	19.7	19.1	18.0	17.8	18.1	18.4	16.9	18.8				12
14		12.9	14.6	14.7	14.2	13.2	12.5	14.5	14.0	12.3	13.5	12.8			14
16			11.3	11.9	11.0	10.0	9.3	11.7	10.8	9.5	10.7	10.4	10.0		16
18			8.4	9.8	9.0	8.0	7.0	9.0	8.2	6.9	7.2	7.2	7.4	7.5	18
20				7.5	7.6	5.8	5.5	7.0	6.3	5.0	5.8	5.8	5.5	5.6	20
22				5.6	6.3	4.2	4.5	5.3	4.5	3.2	4.8	4.6	3.8	3.6	22
24					4.8	2.8	3.5	4.0	3.3	1.8	3.5	3.2	2.5	2.5	24
26					3.7	1.7	2.7	3.0	2.2		2.3	2.0	1.5	1.2	26
28							2.0	1.8	1.3		1.4	1.2	0.0		28
30							1.5	1.2							30

Load Chart - Telescopic Boom

Unit: t



Radius (m)	13.8	18.2	22.6	27.2	31.5	36.1	40.4	44.9	49.4	53.8	58.2	62.7	67.1	73	Radius (m)
3	250.0														3
3.5	160.0	155.0													3.5
4	150.0	145.0	140.0												4
4.5	145.0	136.0	132.0	120.0											4.5
5	135.0	128.0	123.0	115.0	110.0										5
6	120.0	113.0	110.0	103.0	101.0										6
7	106.0	80.5	79.4	87.0	80.0	75.0									7
8	72.1	72.1	72.1	73.0	67.0	65.0	65.0								8
9	64.8	64.8	64.2	61.0	60.3	62.0	62.0	51.5							9
10	56.1	56.0	55.5	52.0	53.0	54.0	50.0	47.9	40.9						10
11		48.8	48.5	46.2	47.5	48.0	46.0	44.6	38.7	35.0					11
12		43.5	43.0	40.3	42.0	44.5	43.5	41.8	36.8	34.0	27.7				12
14		34.7	34.7	32.2	33.5	36.3	35.0	33.5	32.8	30.5	26.6	21.0			14
16			28.1	26.5	28.0	30.0	29.0	29.5	29.3	27.5	23.9	20.8	18.1		16
18			25.5	22.3	23.5	25.4	25.1	24.5	24.5	24.6	21.6	19.3	17.0	13.4	18
20				19.0	20.0	22.0	21.5	21.4	21.0	21.3	19.8	17.6	15.9	13.0	20
22				16.0	17.0	19.7	18.5	19.5	18.0	18.1	18.0	16.2	14.9	12.1	22
24					15.0	17.1	16.5	17.1	16.6	16.2	15.0	15.0	14.0	11.3	24
26					13.0	15.2	14.5	15.0	14.5	14.0	13.0	14.0	13.1	10.7	26
28						13.4	13.0	13.7	12.5	12.3	11.0	12.1	12.3	10.0	28
30						12.0	11.5	12.0	11.0	11.3	10.2	11.4	11.4	9.4	30
32							10.0	10.5	10.2	9.5	9.5	10.7	10.0	8.8	32
34							9.0	9.7	9.5	8.6	9.0	9.5	9.0	8.4	34
36								9.1	9.0	7.8	8.5	8.5	8.0	7.9	36
38								8.4	8.6	7.0	8.0	7.5	7.2	7.5	38
40									7.5	6.2	7.5	6.8	6.3	7.1	40
42									7.0	5.5	7.0	6.2	5.5	5.6	42
44										5.0	6.2	5.5	5.0	5.0	44
46										4.5	5.0	5.0	4.5	4.5	46
48											4.5	4.5	4.0	4.0	48
50											4.0	4.0	3.5	3.5	50
52											3.5	3.5	3.0	3.0	52
54												3.0	2.5	2.5	54
56												2.5			56

Load Chart - Telescopic Boom

Unit: t

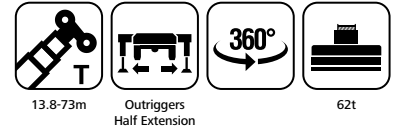

Radius (m)	13.8	18.2	22.6	27.2	31.5	36.1	40.4	44.9	49.4	53.8	58.2	62.7	67.1	73	Radius (m)
3	250.0														3
3.5	155.0	155.0													3.5
4	150.0	145.0	140.0												4
4.5	140.0	135.0	132.0	115.0											4.5
5	130.0	126.0	123.0	110.0	101.0										5
6	108.0	95.0	92.0	90.0	83.0										6
7	85.0	75.0	74.0	72.5	72.0	65.0									7
8	67.0	62.0	59.6	55.3	60.0	58.0	56.9								8
9	56.5	53.3	51.2	43.5	48.0	51.1	52.0	45.0							9
10	48.0	46.0	45.0	41.3	41.3	40.9	42.0	42.2	40.9						10
11		40.0	39.2	36.1	37.6	35.9	36.1	36.0	36.7	33.1					11
12		35.6	35.0	33.0	33.0	31.9	33.2	32.2	30.0	32.2	27.7				12
14		28.5	28.0	26.0	26.5	26.8	28.1	27.1	26.0	25.5	26.6	21.0			14
16			23.5	21.0	22.0	22.0	22.8	22.5	20.3	22.6	20.0	20.8	18.1		16
18			20.0	17.8	18.5	18.5	19.1	19.9	18.8	18.3	17.5	19.3	17.0	13.4	18
20				14.8	15.8	17.8	17.3	17.2	16.7	16.2	16.0	16.4	15.9	12.5	20
22				13.4	13.5	16.0	15.0	15.5	15.0	13.8	14.7	13.2	10.8	12.0	22
24					11.8	14.1	13.2	13.5	13.0	12.1	13.2	11.8	9.5	11.0	24
26					10.5	12.5	11.8	11.8	11.4	10.7	10.3	10.5	9.0	10.5	26
28						11.2	10.5	10.5	10.0	9.4	9.2	9.4	8.0	10.0	28
30						10.0	9.3	10.0	9.3	8.3	8.2	8.4	7.0	6.0	30
32							8.4	9.0	8.5	7.5	7.5	7.4	6.1	5.2	32
34							7.5	8.2	7.6	6.7	7.0	6.6	5.3	4.6	34
36								7.8	6.9	6.0	6.6	5.9	4.6	4.0	36
38								7.2	6.3	5.4	6.0	5.3	4.0	3.5	38
40									5.7	4.8	5.4	4.8	3.3	3.0	40
42									5.2	4.3	4.9	4.5	2.8	2.4	42
44										3.8	4.4	4.3	2.4	2.0	44
46											4.0	3.9	1.9		46
48											3.6	3.5	1.5		48
50												3.0			50
52												2.7			52
54												2.4			54

Load Chart - Telescopic Boom

Unit: t



Radius (m)	13.8	18.2	22.6	27.2	31.5	36.1	40.4	44.9	49.4	53.8	58.2	62.7	67.1	73	Radius (m)
3	160.0														3
3.5	155.0	155.0													3.5
4	150.0	145.0	140.0												4
4.5	140.0	135.0	132.0	115.0											4.5
5	130.0	126.0	123.0	110.0	101.0										5
6	108.0	95.0	92.0	90.0	83.0										6
7	85.0	75.0	74.0	72.5	72.0	65.0									7
8	62.3	60.7	59.6	55.3	60.0	58.0	56.9								8
9	52.0	51.6	51.2	43.5	48.0	51.1	52.0	45.0							9
10	44.4	44.9	43.4	41.3	41.3	40.9	42.0	42.2	40.9						10
11		38.8	38.2	36.1	37.6	35.9	36.1	36.0	36.7	33.1					11
12		33.7	34.0	31.4	33.0	31.9	33.2	32.2	30.0	32.2	27.7				12
14		26.2	26.6	24.9	26.5	26.8	28.1	27.1	26.0	25.5	26.6	21.0			14
16			22.0	19.7	21.6	22.0	22.8	22.5	20.3	22.6	20.0	20.8	18.1		16
18			19.0	16.8	17.7	18.5	19.1	19.9	18.8	18.3	17.5	19.3	17.0	13.4	18
20				14.0	14.7	17.2	17.0	17.2	16.7	16.2	16.0	16.4	15.9	12.5	20
22				13.3	13.2	14.9	14.2	15.5	15.0	13.8	14.7	13.2	10.8	12.0	22
24					11.5	13.3	12.0	13.5	13.0	12.1	13.2	11.8	9.5	11.0	24
26					10.5	11.7	10.0	11.8	11.4	10.7	10.3	10.5	9.0	10.5	26
28						10.5	9.6	10.5	10.0	9.4	9.2	9.4	8.0	10.0	28
30						8.5	8.4	9.3	8.9	8.3	8.2	8.4	7.0	6.0	30
32							7.2	8.3	7.8	7.1	7.3	7.4	6.1	5.2	32
34							6.5	7.5	6.9	6.3	6.6	6.6	5.3	4.6	34
36								6.8	6.1	5.4	5.9	5.9	4.6	4.0	36
38								6.2	5.4	4.7	5.3	5.3	4.0	3.5	38
40									4.8	4.1	4.8	4.8	3.3	3.0	40
42									4.3	3.3	4.2	4.3	2.8	2.4	42
44										2.6	3.6	3.8	2.4	2.0	44
46											3.0	3.2	1.9		46
48											2.5	2.6	1.5		48
50												2.2			50
52												1.8			52
54												1.5			54

Load Chart - Telescopic Boom

Unit: t

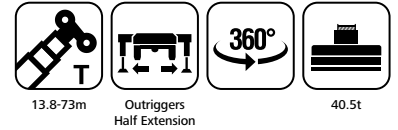

Radius (m)	13.8	18.2	22.6	27.2	31.5	36.1	40.4	44.9	49.4	53.8	58.2	62.7	67.1	73	Radius (m)
3	150.0														3
3.5	137.0	135.0													3.5
4	127.0	125.0	120.0												4
4.5	117.0	115.0	110.0	108.0											4.5
5	106.0	103.0	100.0	100.0	95.0										5
6	90.0	80.0	82.0	80.0	81.0										6
7	74.3	64.2	63.0	60.0	64.0	64.5									7
8	52.3	52.9	50.6	50.7	50.7	50.4	52.2								8
9	45.0	44.8	44.9	41.8	43.0	40.8	42.5	42.0							9
10	38.5	37.7	38.3	35.0	37.0	34.0	35.5	34.1	35.0						10
11		33.6	34.9	30.0	31.1	29.2	30.4	30.5	30.6	32.1					11
12		29.8	30.4	26.2	28.0	24.5	26.0	25.1	28.8	28.5	27.7				12
14		23.8	24.3	20.9	21.0	18.5	21.1	21.6	23.1	23.0	22.6	20.8			14
16			20.3	17.9	18.5	15.2	16.8	17.3	18.2	18.6	18.7	19.2	17.8		16
18			16.6	15.8	16.5	12.7	13.6	14.1	14.6	15.4	17.0	16.7	16.1	13.4	18
20				13.9	14.4	10.8	11.2	11.6	11.8	12.9	14.2	13.9	13.3	12.5	20
22				12.5	12.2	9.3	9.3	9.7	9.6	11.0	11.9	11.6	10.8	11.1	22
24					10.6	8.2	7.7	8.1	8.5	9.5	10.1	9.8	9.2	9.3	24
26					9.8	7.0	6.7	6.8	6.9	8.3	8.6	8.3	7.7	7.8	26
28						6.1	5.8	5.9	6.0	7.2	7.3	7.0	6.5	6.5	28
30						5.2	5.0	5.2	5.2	6.0	6.3	6.0	5.4	5.4	30
32							4.3	4.6	4.5	5.2	5.3	5.0	4.5	4.5	32
34							3.6	4.0	4.0	4.6	4.5	4.2	3.7	3.7	34
36								3.5	3.2	3.8	3.8	3.5	3.0	3.1	36
38								3.0		3.0	3.2	2.9	2.5	2.6	38
40										2.3	2.8	2.5	2.1	2.2	40
42										1.8	2.4	2.1			42
44										1.2	2.0				44

Load Chart - Telescopic Boom

Unit: t



Radius (m)	13.8	18.2	22.6	27.2	31.5	36.1	40.4	44.9	49.4	53.8	58.2	62.7	67.1	73	Radius (m)
3	150.0														3
3.5	136.0	135.0													3.5
4	124.0	120.0	115.0												4
4.5	111.0	108.0	105.0	105.0											4.5
5	101.0	95.0	95.0	90.0	90.0										5
6	80.0	70.0	68.0	65.0	68.0										6
7	62.1	55.0	53.0	50.5	53.1	55.4									7
8	44.2	44.0	46.3	40.8	43.1	44.6	45.0								8
9	37.0	39.0	38.4	34.0	35.6	38.1	37.1	37.1							9
10	31.8	33.0	33.4	29.0	30.7	31.9	32.1	31.1	31.6						10
11		27.9	29.4	24.9	26.2	28.0	28.0	27.3	27.6	27.0					11
12		25.2	25.8	22.8	24.0	24.4	24.7	25.1	24.4	24.0	24.1				12
14		19.1	20.7	20.0	20.3	18.5	20.1	20.6	19.6	18.6	20.0	19.7			14
16			16.5	16.5	17.0	15.2	15.8	17.3	16.0	14.5	16.8	16.5	15.8		16
18			13.3	14.0	13.8	12.6	13.6	14.1	13.0	12.0	13.6	13.3	12.7	12.7	18
20				11.6	12.3	10.0	11.2	11.6	10.7	9.9	11.2	10.9	10.3	10.3	20
22				10.0	10.4	8.5	9.3	9.7	9.0	8.5	9.2	8.9	8.3	8.4	22
24					9.0	7.2	7.7	8.1	7.5	7.0	7.7	7.4	6.8	6.8	24
26					8.0	6.3	6.4	6.8	6.5	6.0	6.4	6.1	5.6	5.8	26
28						5.5	5.3	5.9	5.7	5.0	5.3	5.2	4.8	4.8	28
30						4.5	4.6	5.2	5.0	4.3	4.6	4.5	4.0	4.2	30
32							3.8	4.5	4.3	3.5	4.0	3.8	3.4	3.5	32
34							3.2	4.0	3.5	2.5	3.3	3.2	2.8	3.0	34
36								3.5	3.0	1.8	2.8	2.7	2.2	2.5	36
38								3.0		1.2	2.2				38

Load Chart - Telescopic Boom

Unit: t

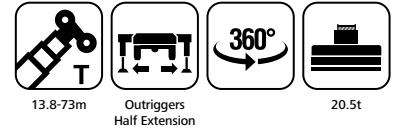

Radius (m)	13.8	18.2	22.6	27.2	31.5	36.1	40.4	44.9	49.4	53.8	58.2	62.7	67.1	73	Radius (m)
3	146.0														3
3.5	132.0	127.0													3.5
4	118.0	114.0	110.0												4
4.5	106.0	92.0	90.0	90.0											4.5
5	87.0	78.0	75.0	75.0	75.0										5
6	65.6	56.6	56.0	53.7	55.0										6
7	50.0	45.0	45.9	41.0	42.8	43.3									7
8	36.3	36.4	37.5	32.9	34.2	35.5	36.0								8
9	28.4	30.3	31.1	28.7	31.0	30.1	30.5	30.9							9
10	23.7	26.0	27.2	26.4	27.0	24.9	26.0	26.8	26.0						10
11		23.0	23.5	23.6	24.0	22.6	22.4	23.5	22.8	21.7					11
12		19.6	21.0	21.5	20.9	19.4	19.6	20.8	20.0	18.1	20.0				12
14		15.0	16.1	16.7	16.8	15.7	15.5	16.5	16.0	14.0	15.5	15.1			14
16			12.5	13.1	14.1	11.9	12.2	13.4	11.8	10.6	12.9	12.5	11.9		16
18			10.0	10.8	11.4	9.7	10.2	10.7	9.0	8.3	10.2	9.9	9.3	9.3	18
20				9.0	9.3	7.6	8.2	8.6	7.5	6.8	8.2	7.9	7.2	7.3	20
22				7.5	7.7	6.4	6.6	7.0	6.3	5.6	6.5	6.2	5.6	5.7	22
24					6.6	5.5	5.2	5.7	5.3	4.5	5.2	4.9	4.3	4.4	24
26					5.8	4.5	4.2	5.0	4.6	3.7	4.3	3.9	3.3	3.3	26
28						3.8	3.2	4.2	4.0	2.8	3.6	3.2	2.4	2.6	28
30						3.0	2.5	3.6	3.2	1.8	3.0	2.5	2.0	2.0	30
32							2.0	3.0	2.3		2.5				32
34								2.2							34
36								1.5							36

Load Chart - Telescopic Boom

Unit: t



Radius (m)	13.8	18.2	22.6	27.2	31.5	36.1	40.4	44.9	49.4	53.8	58.2	62.7	67.1	73	Radius (m)
3	135.0														3
3.5	125.0	125.0													3.5
4	111.0	108.0	105.0												4
4.5	100.0	92.0	90.0	90.0											4.5
5	80.9	78.0	72.8	72.8	75.0										5
6	46.7	50.6	50.4	50.0	50.7										6
7	35.7	35.0	36.1	35.0	38.4	40.0									7
8	25.0	28.5	29.2	28.4	30.2	27.6	28.5								8
9	20.5	23.0	24.0	23.7	23.8	22.7	23.8	23.0							9
10	17.5	18.3	20.1	20.2	21.0	19.5	18.9	20.1	18.6						10
11		16.0	18.2	18.0	18.0	16.9	16.0	17.1	15.8	14.9					11
12		14.0	15.7	15.8	16.3	13.3	14.0	15.0	13.2	12.9	14.0				12
14		10.5	11.5	12.5	13.1	10.2	10.5	12.0	10.5	9.5	10.9	10.5			14
16			8.6	9.5	10.2	8.0	8.5	9.4	8.2	7.5	8.9	8.6	11.0		16
18			7.0	7.3	8.0	6.0	6.0	7.3	6.0	5.5	6.8	6.5	8.5	8.5	18
20				5.8	6.3	4.8	4.5	5.6	4.8	4.0	5.1	4.8	6.6	6.7	20
22				4.8	5.0	3.8	3.4	4.3	3.8	3.0	3.8	3.5	5.0	5.2	22
24					4.2		2.5	3.5	3.1	2.2	3.0	2.6	3.8	3.9	24
26					3.5		1.9	2.8	2.5		2.2	2.0	2.7	2.8	26
28								2.0					1.8	1.9	28
30													1.0	1.1	30

Unit: t



Radius (m)	13.8	18.2	22.6	27.2	31.5	36.1	40.4	44.9	49.4	Radius (m)
3	130									3
3.5	120	115								3.5
4	100	90	95							4
4.5	72	70	70	75						4.5
5	54	54	60	50	55					5
6	34	33	40	35.9	35					6
7	24	25	28.5	27	28.2	28				7
8	17	20	22	22	22	20	20			8
9	13.5	15.5	16.5	18	18	16	16	17.5		9
10	10	12.5	14	15	15	11.5	13	15	14	10
11		10	12	12	13	9	9.5	12.5	11	11
12		8	9	10	11	7	7.5	10	8.2	12
14		5	6.8	7	8	5	5.2	7	6	14
16			4.5	5.5	6	3.5	3.6	5	4.4	16
18			2.6	3.8	4.2	2	2.5	3.2	2.5	18
20				2.5	2.9		1.8	1.8	1.2	20
22					1.7					22

Jib Operating Range

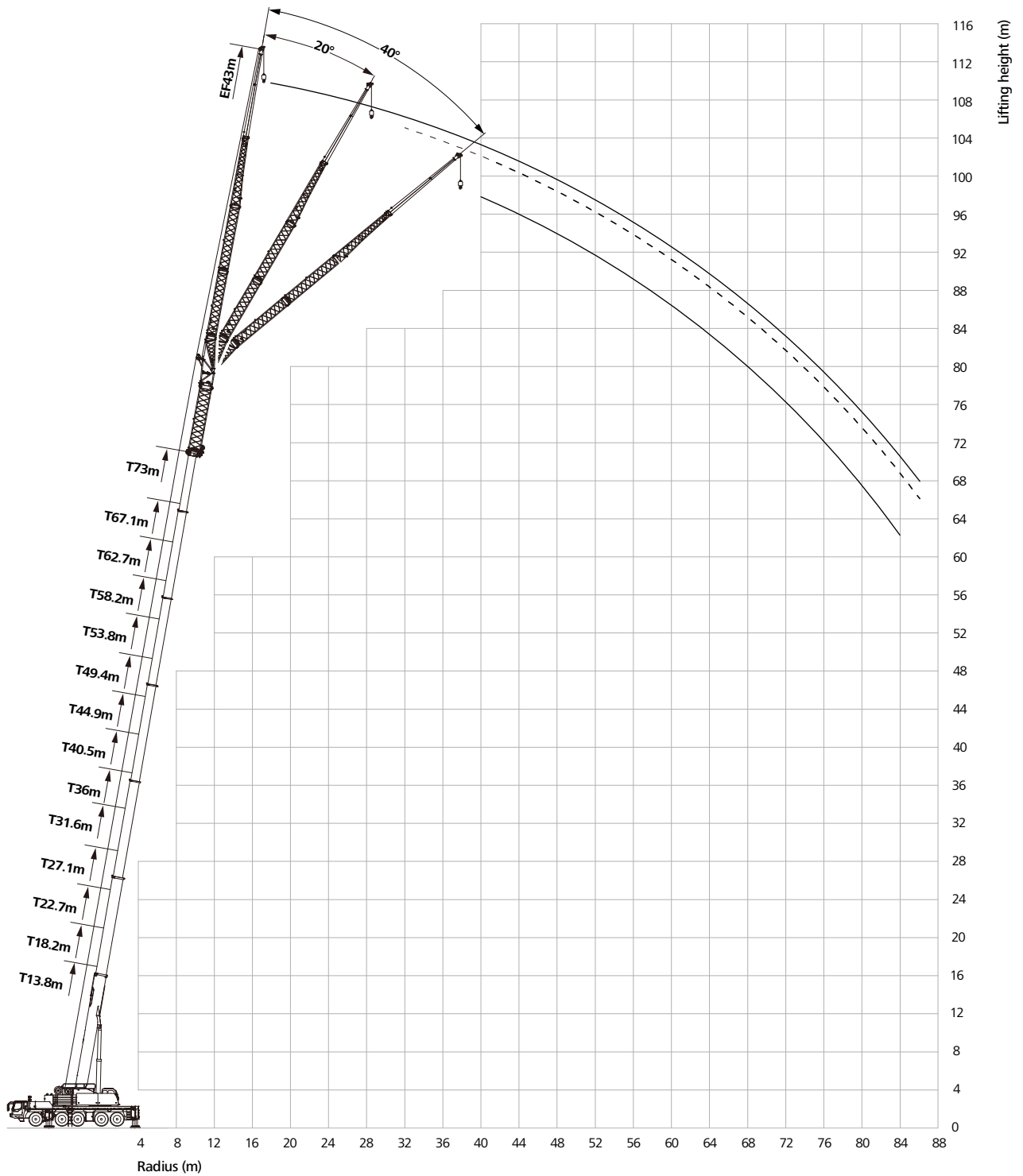

Load Chart - Fixed Jib

Unit: t

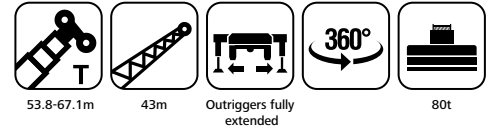

Radius(m)	53.8m +36m+7m			58.2m +36m+7m			62.7m +36m+7m			67.1m +36m+7m			Radius(m)
	0°	20°	40°	0°	20°	40°	0°	20°	40°	0°	20°	40°	
16	3.7												16
18	3.7												18
20	3.7												20
22	3.5			3.1						1.7			22
24	3.5			3.1			2.8			1.7			24
26	3.5			3.0			2.7			1.7			26
28	3.4	2.9		2.9	2.2		2.7			1.7			28
30	3.4	2.9		2.9	2.2		2.6	2.1		1.7			30
32	3.4	2.9		2.8	2.2		2.6	2.1		1.7	1.5		32
34	3.3	2.9		2.8	2.2		2.5	2.1		1.7	1.5		34
36	3.2	2.8		2.7	2.2		2.5	2.1		1.7	1.5		36
38	3.1	2.7	1.5	2.6	2.2	1.7	2.5	2.0	1.5	1.7	1.5		38
40	2.8	2.6	1.5	2.6	2.1	1.7	2.4	2.0	1.5	1.7	1.5	1.4	40
42	2.6	2.4	1.5	2.5	2.1	1.7	2.4	2.0	1.5	1.7	1.5	1.4	42
44	2.4	2.2	1.5	2.5	2.0	1.6	2.3	1.9	1.5	1.7	1.5	1.4	44
46	2.2	2.0	1.4	2.4	2.0	1.6	2.3	1.9	1.4	1.7	1.5	1.4	46
48	1.9	1.8	1.4	2.4	2.0	1.6	2.2	1.9	1.4	1.7	1.5	1.4	48
50	1.8	1.5	1.4	2.3	2.0	1.5	2.2	1.9	1.4	1.7	1.5	1.4	50
52	1.8	1.5	1.4	2.3	1.9	1.5	2.2	1.8	1.4	1.7	1.4	1.4	52
54	1.8	1.5	1.4	2.3	1.9	1.5	2.1	1.8	1.4	1.6	1.4	1.4	54
56	1.7	1.5	1.4	2.2	1.9	1.5	2.1	1.8	1.4	1.6	1.4	1.4	56
58	1.7	1.5	1.4	2.2	1.8	1.5	2.1	1.8	1.4	1.5	1.4	1.4	58
60	1.6	1.5	1.4	2.1	1.8	1.5	2.0	1.7	1.4	1.5	1.4	1.4	60
62	1.6	1.4	1.4	2.0	1.8	1.4	1.9	1.4	1.4	1.5	1.4	1.4	62
64	1.5	1.4	1.4	1.8	1.7	1.4	1.8	1.4	1.4	1.4	1.4	1.4	64
66	1.5	1.4	1.4	1.8	1.7	1.4	1.7	1.4	1.4	1.4	1.4	1.4	66
68	1.4	1.4	1.4	1.8	1.7	1.4	1.7	1.4	1.4	1.4	1.3	1.4	68
70	1.4	1.4	1.4	1.7	1.4	1.4	1.6	1.4	1.4	1.3	1.3	1.3	70
72	1.4	1.4		1.7	1.4	1.4	1.5	1.3	1.4	1.2	1.3	1.3	72
74	1.4	1.3		1.6	1.3	1.4	1.4	1.3	1.4	1.1	1.2	1.3	74
76	1.3	1.3		1.5	1.3		1.3	1.3	1.4	1.0	1.2	1.2	76
78	1.1	1.3		1.3	1.3		1.3	1.3		0.9	1.1	1.2	78
80		1.2		1.3	1.3		1.1	1.2			1.0	1.1	80
82		1.1		1.3	1.2		1.1	1.2			0.9	1.1	82
84					1.1			1.1				0.9	84
Rope rate	1	1	1	1	1	1	1	1	1	1	1	1	Rope rate



SANY GROUP CRANE BU

SANY Mobile Crane Industrial Park, No.168 Jinzhou Avenue, Jinzhou Development Zone, Changsha City, Hunan Province, P.R. China Zip 410600

Consulting sanycrane@sanygroup.com (Crane BU) / crd@sany.com.cn (IHQ)

After-sales Service 0086-400 6098 318

Reminder:

Any change in the technical parameters and configuration due to product modification or upgrade may occur without prior notice. The machine in the picture may include additional equipment. This brochure is for reference only, and goods in kind shall prevail.

Copyright at SANY. No part of this brochure may be copied or used for any purpose without written approval from SANY.

© Edited in January 2022

